

Task 45 Large Systems

Seasonal pit heat storages - Guidelines for materials & construction

IEA-SHC TECH SHEET 45.B.3.2, page 1 of 31

Subject:	Seasonal storages
Date:	1 December 2014
Description:	Guidelines for design of seasonal pit heat storages.
Author:	Morten Vang Jensen, PlanEnergi
Download possible at:	http://task45.iea-shc.org/fact-sheets

Contents

Introduction	2
Design of the storage.....	2
Shape and soil balance	2
Lining materials	2
Floating cover	6
In-/outlet arrangement	13
Water quality	15
Location of storage and geotechnical conditions	16
Ground water conditions.....	16
Geotechnical investigations	16
Calculation and optimization of pit heat storages.....	17
Simulation tool (TRNSYS).....	17
Optimization of storage size and shape	18
Costs of pit heat storages	20
Examples of pit heat storages	21
Ottrupgård.....	21
Marstal, SUNSTORE 2	24
Marstal, SUNSTORE 4	27
Dronninglund, SUNSTORE 3.....	30
References	31

Seasonal pit heat storages - Guidelines for materials & construction

IEA-SHC TECH SHEET 45.B.3.2, page 2 of 31

Introduction

Seasonal heat storages in connection to large scale solar plants for district heating has been investigated and implemented in Denmark. For full scale systems the storages has been made as pit thermal energy storages (pit heat storages). In addition to this a borehole thermal energy storage has been implemented as a pilot plant. This fact sheet is a design guideline for pit heat storages based on experience from the design and implementation of the Danish pit heat storages.

In principle a pit heat storage is a large water reservoir for storing of thermal energy. Water is an excellent medium for heat storing as it is cheap, non-toxic and has a high heat capacity. The cost of a water storage mainly consists of the parts surrounding the water: A watertight tank and a thermal insulation. For smaller storages (up to 5 000 m³) typically an insulated steel tank is used but for larger storages a pit heat storage is considerably cheaper per m³ water (app. 1/4 of a steel tank).

Design of the storage

The principal structure of a pit heat storage is quite simple as it consists of an excavation in the ground covered with a water tight liner. The storage is filled with water and covered by a floating insulated cover. But to ensure a functioning and long term durable storage the design has to be handled very carefully in every aspect. The main parts will be described in the following.

Shape and soil balance

The pit heat storage can be designed with different shapes but the simplest is an excavation shaped as a truncated pyramid placed upside down in the ground as shown in figure 1. To minimize the cost of soil handling and transportation the excavation is made with soil balance which means that the soil excavated from the bottom part of the storage is used as embankments around the upper part of the storage. The necessary volume of the storage depends on the overall system it is connected to and it is necessary to make a calculation model of the overall system to find the optimal volume.



Figure 1. Principle sketch of a pit heat storage cross section.

Lining materials

Water tightness of a pit heat storage is obtained by covering the soil with a liner. Depending on the specific cover design a liner is also used for the insulated cover construction. The service life of a pit heat storage is very much dependent of the liner. Water sealing with special clay has been tested in earlier pit heat storages with poor results and at the moment applicable liners for pit heat storages are considered

Seasonal pit heat storages - Guidelines for materials & construction

IEA-SHC TECH SHEET 45.B.3.2, page 3 of 31

different types of polymer liners (PP, PE), elastomer liners (EPDM) and different kinds of metal liners (stainless steel, aluminium).

Polymer and elastomer liners are by far the cheapest regarding both material price and installation cost, but metal liners have an advantage regarding long term stability and vapour tightness.

Polymer liners

Polymer liners as PP and PE are relatively cheap and easy to install with well documented welding and testing techniques. Therefore they are widely used for geomembranes. The welding process is shown in figure 2.

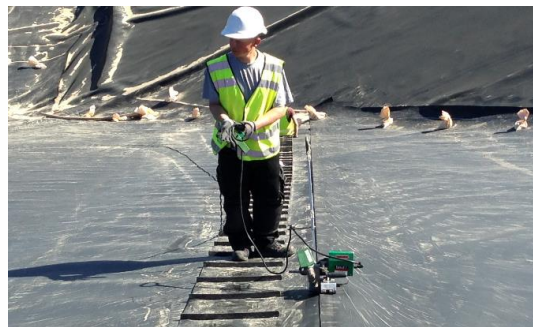
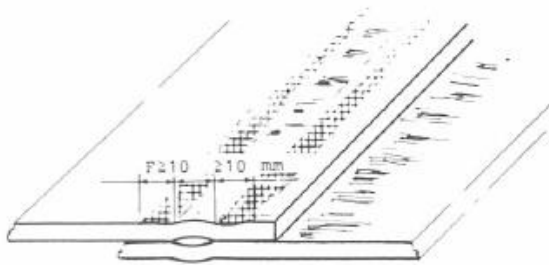

Figure 2. Double welding of a HDPE liner. The welding can be tested by applying pressurized air to the air channel between the welding seams.

The major issue regarding polymer liners is the temperature resistance and another disadvantage compared to metal liners is the water vapour permeability. For polymer liners the water vapour permeability is strongly temperature dependent (see figure 3). HDPE liners have the lowest water vapour permeability compared to other geomembranes. At 20°C the water vapour permeability is around 0.03 g/m²/day for a 1 mm liner. For temperatures above 60°C it is difficult to get data from the suppliers, but experiments have shown a water vapour permeability for a 2.5 mm liner of app. 1.5 g/m²/day at 80°C. [1]). For PP the water vapour permeability is app. 4 times as high as for HDPE. For comparison LDPE has a water vapour permeability 45 times as high and PVC 115 times as high as HDPE [3].

Seasonal pit heat storages - Guidelines for materials & construction

IEA-SHC TECH SHEET 45.B.3.2, page 4 of 31

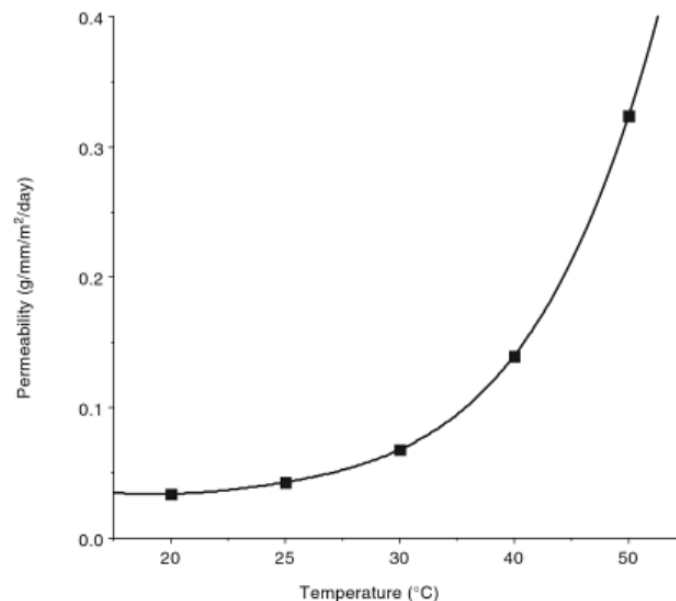

Figure 3. Water vapour permeability as a function of temperature for a typical HDPE liner [3]

The temperature resistance of a polymer liner is dependent on not only the base material but also highly on different additives to the material. But the additives will diffuse out of the material over time especially when exposed to hot water on one side and air/soil on the other side of the liner. A liner material with excellent temperature performance according to the supplier can therefore have very limited lifetime in a pit heat storage.

The Danish Technological Institute has developed a test method for an accelerated life test of polymer liners for pit heat storages. This can be used to test a sample of a liner but for the best liners the test should be expected to take more than a year. From the test results and the expected temperature profile of the storage through the year an expected service life of the liner can be predicted. The best liners tested by this method so far are specific high temperature developed HDPE liners which have an expected lifetime of not more than 3 years at a constant temperature of 90°C. For a typical temperature profile of a pit heat storage connected to a solar plant the life time of the liner can though be calculated to more than 20 years. For another material tested (a specific PP liner) the life time at same conditions would be less than 6 years. This span shows the importance of careful liner selection. Test reports for testing of different liners in the period 2000 to 2013 can be found in Danish at the Danish Technological Institute [2].

The development of high temperature polymer liners has accelerated as the demand grows. Newly developed high temperature HDPE liners are claimed and guaranteed by the supplier to have a lifetime of more than 20 years at 90°C constant. This liner is used for the SUNSTORE 3 storage in Dronninglund, but it is not tested yet according to the method from the Danish Technological Institute.

Seasonal pit heat storages - Guidelines for materials & construction

IEA-SHC TECH SHEET 45.B.3.2, page 5 of 31

The cost of a HDPE liner is app 16 €/m² including installation and welding which represents 4 to 5 €/m² (budget from SUNSTORE 3).

Elastomer liners

EPDM liners have a higher temperature resistance than PP and PE liners, and would be useful above 90°C. EPDM is not weldable and has to be bonded by special vulcanising glue. The price including installation is app. 25% higher than for HDPE liners. Another disadvantage of an EPDM liner is that the vapour permeability is around double as high as for HDPE liners [4]. For the bottom and side liner for a pit heat storage this is not a major problem. If it is used for floating liner in a cover construction the vapour penetration has to be handled in order to avoid moisturizing and decomposition of the insulation used.

Metal liners

Metal liners have the advantage over polymer and elastomer liners that they can resist very high temperatures and they are water vapour tight. The disadvantage is the material cost and the installation cost which are considerably higher.

In a project sponsored by the Danish district heating organisation there has been focused on the development of liners for pit heat storages. The project is carried out by PlanEnergi, Marstal District heating company, The Danish Technological Institute and Force Technology. In this project the material cost for a stainless steel liner or an aluminium liner was estimated to be app. 3 times as high as for a HDPE liner. In addition to this the installation costs are estimated to be double as high.

For metal liners it is very important to be aware of corrosion issues. On the water side it is possible to secure a water chemistry that is non-harmful to as well grades of stainless steel as grades of aluminium. The water chemistry and steel grade should be evaluated by a corrosion specialist. On the soil side the corrosion behaviour is more unpredictable. In general stainless steel in an acid proof grade (AISI 316) or Duplex grade is considered suitable, but it has to be evaluated by a corrosion specialist for a specific case.

The metal liners can be delivered in coils of up to 1.500 mm width and welded on site. The most promising welding technique is an induction welding where bendings along the edges are welded together by a special induction welder (see figure 4). This process has been used in a 3000 m³ pit heat storage (Tubberupvænge). The storage was made in 1990 with EPDM lining but due to unacceptable leakage it was covered with a stainless steel liner in 1997. The welding equipment is today not available as standard equipment and has to be manufactured for the purpose.

Seasonal pit heat storages - Guidelines for materials & construction

IEA-SHC TECH SHEET 45.B.3.2, page 6 of 31



Figure 4. Induction welding of a stainless steel liner [5]

Floating cover

The top surface of the pit heat storage is covered by an insulated floating cover. The cover is the most expensive part of the storage and therefore a lot of effort has been put into investigations of different designs and materials. The overall designs investigated in Denmark can be divided into three categories:

- 1- Cover based on flexible insulation mats
- 2- Cover based on Stiff insulation elements
- 3- Cover based on bulk insulation

The first category is based on flexible insulation mats contained within a watertight floating liner and a top liner. The flexibility allows the insulation to cover the water surface and the edges of the storage as a single unit while the surface is allowed to move up and down due to thermal expansion of the water. Base materials for the insulation are typically polymers or elastomers. For the SUNSTORE 3 and 4 storages a flexible insulation type has been used (Nomalen 28N from NMC). Nomalen is based on a chemically cross linked polyethylene foam with a closed cell structure. The base material is LDPE, but the cross linking makes the insulation more heat resistant than ordinary LDPE. According to the supplier the material has a working temperature of up to 95°C. The Danish technological institute has evaluated the temperature stability from data from the supplier and expects the Nomalen insulation to be as resistant to high temperatures as the HDPE liners used for floating cover. According to the Danish technological institute it is though important to avoid water vapour in contact to the insulation because of the risk of condensating water inside the foam cells. This is the principle used in the largest implemented pit heat storages so far in Denmark (January 2015) and will be described in further detail.

The second category is based on stiff insulation elements either floating directly on the water or contained between watertight liners as for the flexible cover. Stiff insulation elements made of e.g. PUR or PIR foam typically have better temperature and moisture resistance than flexible insulation made of polymer. When

Seasonal pit heat storages - Guidelines for materials & construction

IEA-SHC TECH SHEET 45.B.3.2, page 7 of 31

using elements in direct contact to the water special care has to be taken because the insulation material itself cannot withstand the hot water over time. Therefore the insulation material has to be coated or contained in a vapour tight lining. Different kinds of polyurea coating has been tested but experiments has shown that this is insufficient. From the experiments it was concluded that a metal lining was necessary and a 0.75 mm aluminium plate could solve the problem. The thickness and grade of aluminium has to be carefully chosen with respect to water chemistry and corrosion. Because of the low flexibility of the insulation special care has to be taken along the edges of the storages to handle temperature expansion of the insulation elements and changes of water level due to thermal expansion of the water. An almost 20 year old pit heat storage of 1 500 m³ (Ottrupgaard) has a cover based on stiff insulation elements and is still in operation.

The third category is based on bulk insulation like e.g. expanded clay or expanded glass balls. The insulation is contained between a watertight floating liner and a top liner. Because of the open structure of the insulation and the fact that the temperature is high below the insulation and low above the insulation there is a high risk of significant convection. This has to be investigated for the specific grade of insulation and eventual precautions like convection barriers have to be built into the cover. Also for the bulk insulation it is important to be aware of the material properties with respect to moisture. When using expanded clay there is a risk that the insulation will absorb moisture and thereby have a significant lower insulation value. Calculations have been carried out to prove that this can be avoided by relatively low ventilation of the insulation but it is not demonstrated in reality. Because there is limited cohesiveness in the bulk insulation there is also a risk that the insulation particles will not remain in the same place as when installed because of movements of the cover by weather impact, temperature expansion etc. To avoid clumping of the insulation with areas losing the insulation value this has to be considered in the design. To keep the water level as steady as possible it should also be advised to counteract temperature expansion by pumping in and out water from the storage to a reservoir. A cover based on expanded clay insulation will be implemented on pit heat storages in the Danish cities Gram and Vojens in 2015.

Cover based on flexible insulation mats

The two largest pit heat storages in operation in Denmark are the "SUNSTORE 4" storage in Marstal (75 000 m³) and the "SUNSTORE 3" storage in Dronninglund (60 000 m³). They have an almost identical design of the floating cover. The SUNSTORE 3 storage is the latest implemented storage and therefore has some minor design improvements compared to the SUNSTORE 4 storage. A cross section of the design is shown in figure 5 and figure 9.

Task 45 Large Systems

Seasonal pit heat storages - Guidelines for materials & construction

IEA-SHC TECH SHEET 45.B.3.2, page 8 of 31

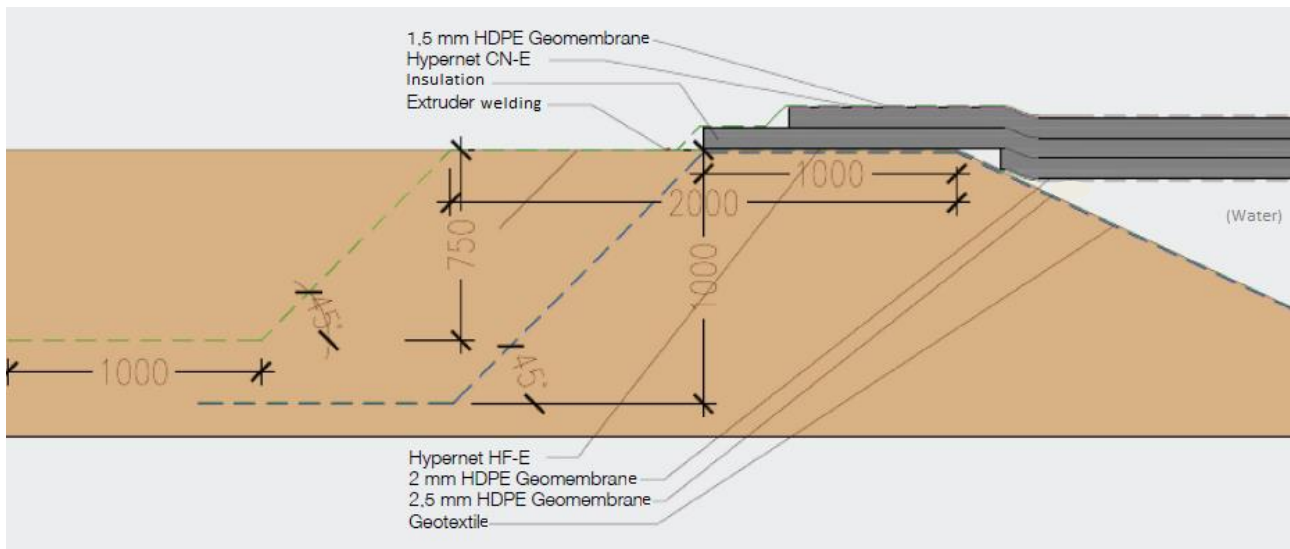

Figure 5. Cross section of the edge of a floating cover based on flexible insulation mats. The specific design is from the 60 000 m³ SUNSTORE 3 storage in Dronninglund.

The floating cover is built up by a liner floating directly on the water surface (The green dotted line in figure 5). This liner can be locked in an anchor trench as shown in the figure. The geometry of the anchor trench is dimensioned according to the length and inclination of the sides of the storage. The liner is installed with some slack to accommodate for thermal expansion. This slack will be stretched out by placing weight pipes from corner to corner on the liner. When the slack increases because of thermal expansion the weight pipes will draw the liner around the pipes deeper into the water and thereby absorb the excess slack. The weight pipes can be made of HDPE pipes welded together and filled with concrete. The pipes are increased in diameter towards the center of the storage to create a small inclination towards the center. This helps to guide eventual water inside the cover towards the center and air bobbles below the cover towards the edges of the storage. An example of a weight pipe layout is shown in figure 6 and a section view in figure 7.

Task 45 Large Systems

Seasonal pit heat storages - Guidelines for materials & construction

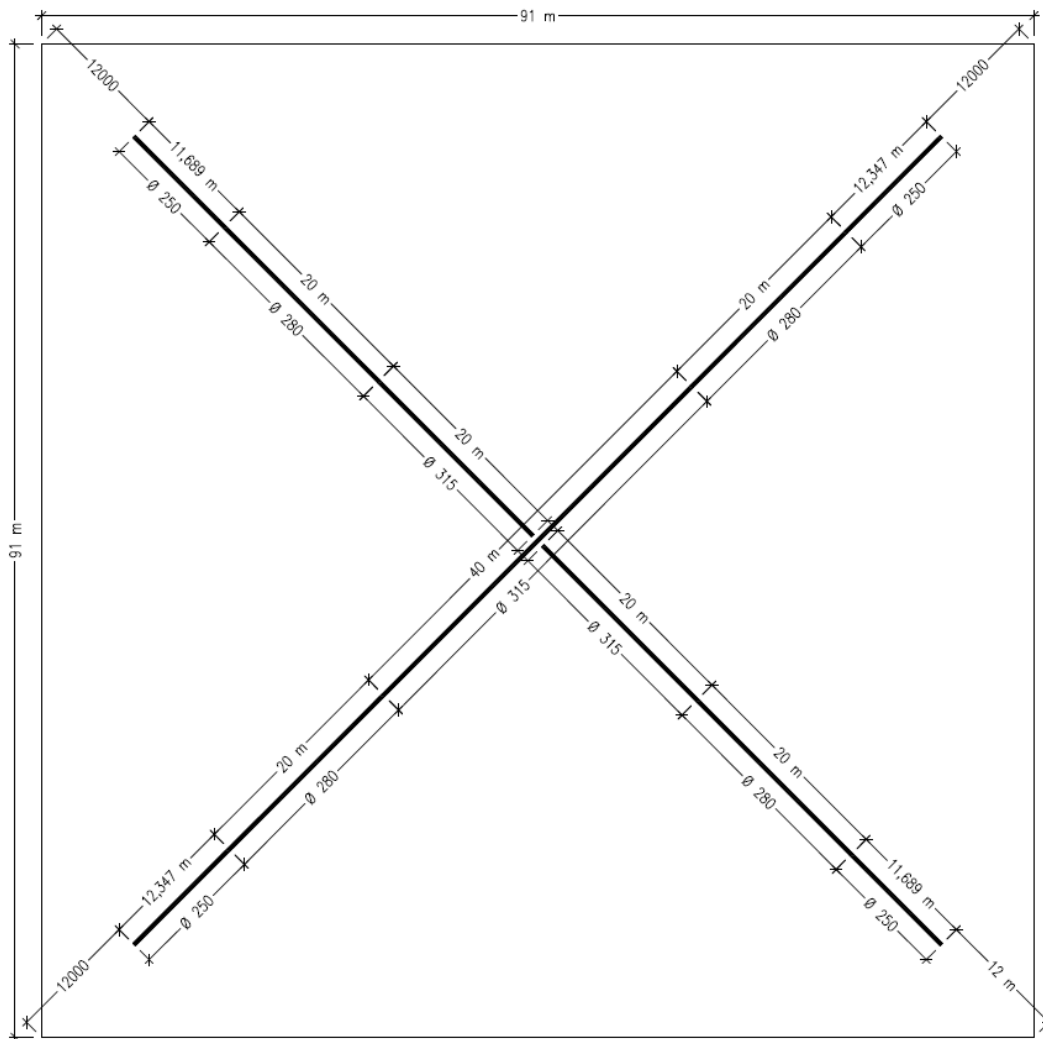

Figure 6. Example of a layout of the weight pipes on the floating liner.

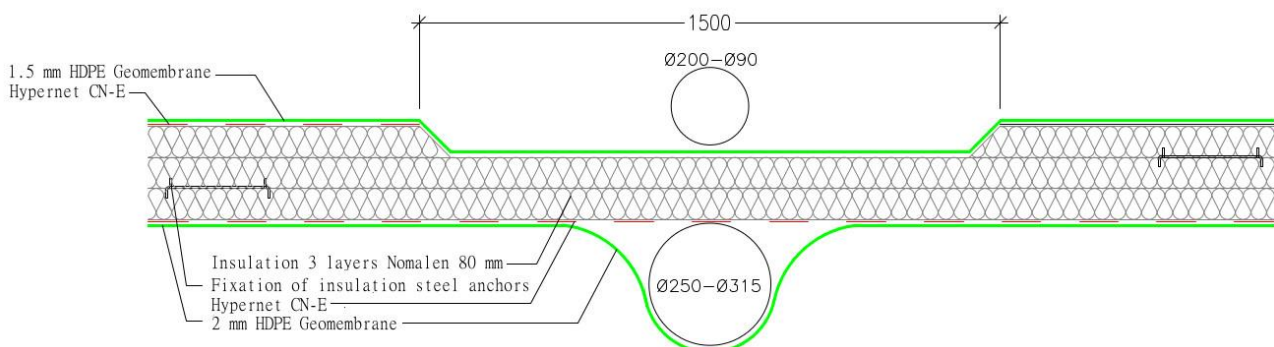

Figure 7. Section drawing of the weight pipe on the floating liner.

Seasonal pit heat storages - Guidelines for materials & construction

IEA-SHC TECH SHEET 45.B.3.2, page 10 of 31

Between the floating liner and the insulation a ventilation gap is made. This is done to be able to vent away moisture in the cover. The moisture can come from vapour penetrating the lower liner unless the liner is completely vapour tight or a vapour barrier is built in. The amount of vapour penetrating through the liner is material and temperature dependent. Moisture can also come from the implementation phase of the cover (rainwater) or as a result of damages to the floating liner or the top liner. If the moisture is not removed from the cover it can result in a degradation of the insulation material. The ventilation gap can be made of a geonet (see figure 8) which separates the liner and the insulation by a small gap (3-6 mm) and thereby allowing water and air to flow between the liner and the insulation.



Figure 8. Geonet used to separate the liner and insulation by a small air gap.

The insulation consists of minimum three layers of insulation mats to reduce thermal bridges. During operation the insulation will expand and contract due to thermal expansion and gaps between the insulation mats should be expected. The optimal total thickness of the insulation is dependent on several factors such as material properties and price, storage geometry, heat price etc. and the optimal thickness can be found by optimization using a mathematical model of the system. Very important material properties for the insulation are the moisture resistance and the long term temperature stability.

The moisture resistance is important because there will always be a risk of moisture or water in the cover either because of damages to the cover resulting in water intrusion or because of condensation of water vapour. Experiences from earlier shows that the use of insulation materials like mineral wool that can absorb water and are difficult to dry out are problematic.

The long term temperature stability is important and it is difficult to find flexible polymer based foam insulation able to withstand long term temperatures above 90°C. In the SUNSTORE 3 and 4 storages a PE based closed cell foam with a crosslinked molecular structure is used which is able to withstand 95°C according to the supplier. The long term properties still need to be proved experimentally and will be monitored in these storages. For higher temperatures elastomeric based foam insulation is considered a better but more expensive material.

Between the insulation and the top liner is again a ventilation gap to be able to ventilate away water vapour in the cover. Along the edges of the storage the top liner is welded to the floating liner as seen in figure 5. Ventilation of the cover is done by roof vacuum vents placed along the edges of the storage. The vacuum vents are mounted as seen in figure 9. The vacuum vents only allow air flow out of the cover. Therefore some of the vacuum vents are modified as needed to allow air flow into the cover. Cold air will

Seasonal pit heat storages - Guidelines for materials & construction

IEA-SHC TECH SHEET 45.B.3.2, page 11 of 31

be drawn into the cover through the modified vents, heated by the warmer atmosphere in the cover while absorbing moisture, and exhausted by the other vacuum vents. In case of severe moisture, e.g. moisture from implementation phase the process can be accelerated by mechanical ventilation (a suction blower connected to one of the vents).

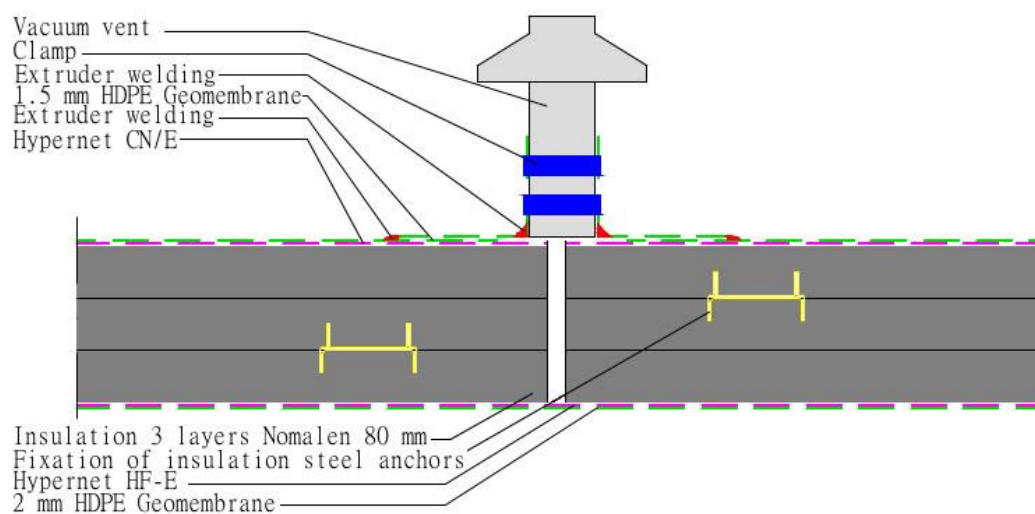

Figure 9. Section view of the cover.

The ventilation of the cover will be able to lower the humidity of the atmosphere in the cover, but it will be insufficient to get rid of large amount of liquid water in the cover. To be able to pump out water a hose is mounted to the bottom part of the cover in the middle of the storage. The other end of the hose is connected to a vacuum pump outside the cover. The vacuum pump can then if necessary pump out water from the bottom of the cover. The water will automatically flow towards the center of the cover because of the design and weight distribution of the cover.

On top of the cover a second array of weight pipes is placed. This weight pipe array keeps the top liner in position and the weight distribution helps to:

- Direct rainwater on top of the cover to a pump at the center of the cover.
- Direct water inside the cover to the suction hose in the center of the cover (In combination with the lower weight pipe).
- Direct air bubbles below the cover toward the edges of the cover (In combination with the lower weight pipe).

An example of a weight pipe layout on top of the cover is shown in figure 10.

Task 45 Large Systems

Seasonal pit heat storages - Guidelines for materials & construction

IEA-SHC TECH SHEET 45.B.3.2, page 12 of 31

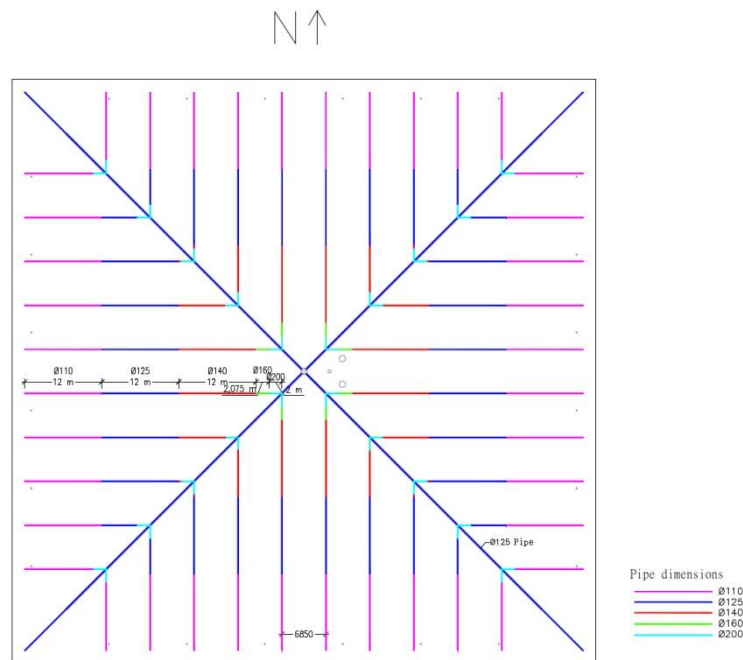

Figure 10. Example of a weight pipe layout on top of the cover.

The weight pipes on top of the cover can also be made of HDPE pipes welded together. When the weight pipes are placed on top of the cover they are filled with concrete.

As the cover of a pit heat storage covers an area of several thousand m² (SUNSTORE 3 and SUNSTORE 4 app. 10 000 m²) it is an important issue to handle rainwater. In principle rainwater can be directed either across the edges of the storage by designing the cover with inclination from the center to the edges or it can be directed towards the center of the storage by making inclination from the edges to the center. The design of a cover with flexible insulation mats is based on the principle of collecting rainwater on the center of the storage. It has the disadvantage that it is necessary to pump the rain water away but the advantages are that the top surface of the cover does not have to be above the edges and also a smaller inclination is necessary. The rainwater collected on the center will help to press the center further down in case of heavy rainfall and thereby minimizing the risk of puddles of water around the cover.

To be able to pump away rain water from the cover it is necessary with a pump capable of the expected rainfall quantities. The cover acts as a water reservoir in case of heavy rainfall and in the SUNSTORE pit heat storages the pumps are dimensioned to be able to remove the rainwater after heavy rainfall (100-year flood) in maximum 4 hours. The pumps should be placed in a pump sump and protected from freezing during winter. It can be done by making an insulated cover around the pump installation and use the heat loss from the pit heat storage.

Task 45 Large Systems

Seasonal pit heat storages - Guidelines for materials & construction

IEA-SHC TECH SHEET 45.B.3.2, page 13 of 31

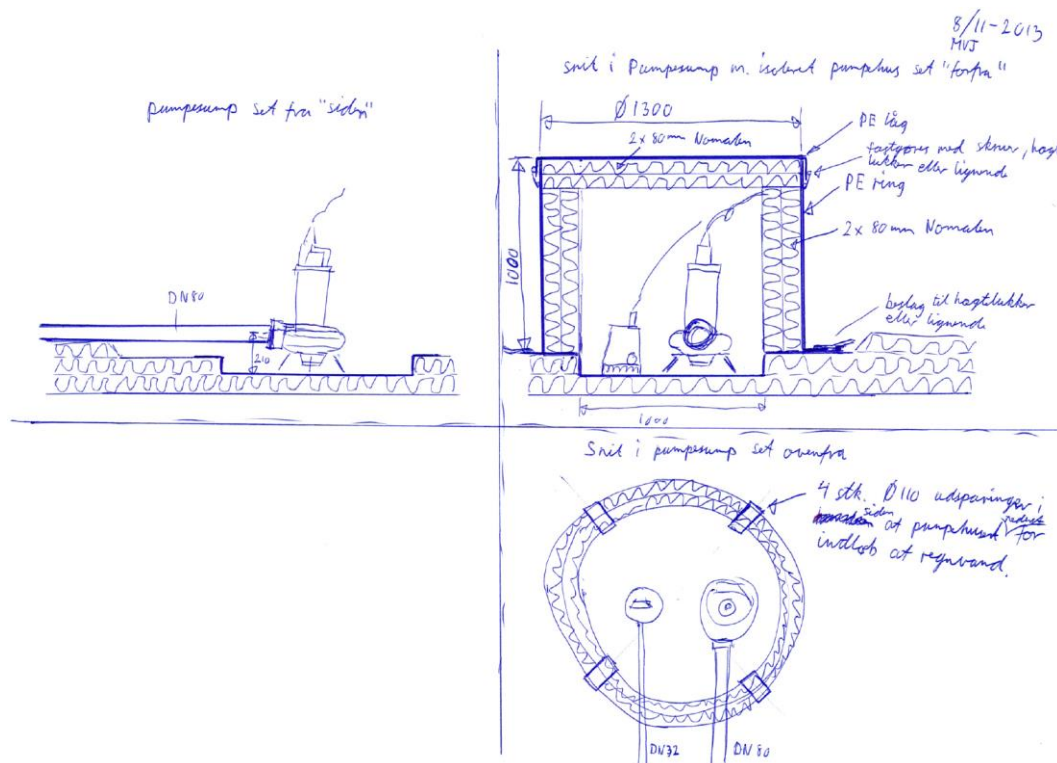

Figure 11. Example of a pump installation for rainwater handling on a pit heat storage.

In-/outlet arrangement

To be able to get energy to and from the storage an in-/outlet arrangement is used. The in-/outlet arrangement consists of at least two pipe connections: One pipe connection led to the bottom of the storage and one pipe connection led to the top of the storage. Dependent on the system connected to the storage and the flexibility wanted it can be advisable with three or five pipe connections in different levels.

The pipe connections can be led through the top cover, the side, or the bottom of the storage. In the SUNSTORE 3 storage it is led through the bottom of the storage and in the SUNSTORE 4 storage it is led through the side of the storage. Pipe connection through the cover has not been implemented in the Danish storages. The pipe connection through the side or bottom liner has to be sealed very carefully to avoid leakage. This can be done by welding a flange to the pipes and clamp the liner between the flange and a collar by a bolt connection. A temperature and moisture resistant gasket is placed between the steel flange and the liner. Directly outside the storage the pipes are kept in place by a concrete construction.

The advantage of letting the pipes enter the bottom of the storage is that the pipes enter the storage perpendicular to the liner. This makes the concrete construction below the liner and the flange connection simpler. The disadvantage compared to a pipe connection through the sides is that the pipes have to be buried deeper in the ground (below the storage).

Task 45 Large Systems

Seasonal pit heat storages - Guidelines for materials & construction

IEA-SHC TECH SHEET 45.B.3.2, page 14 of 31

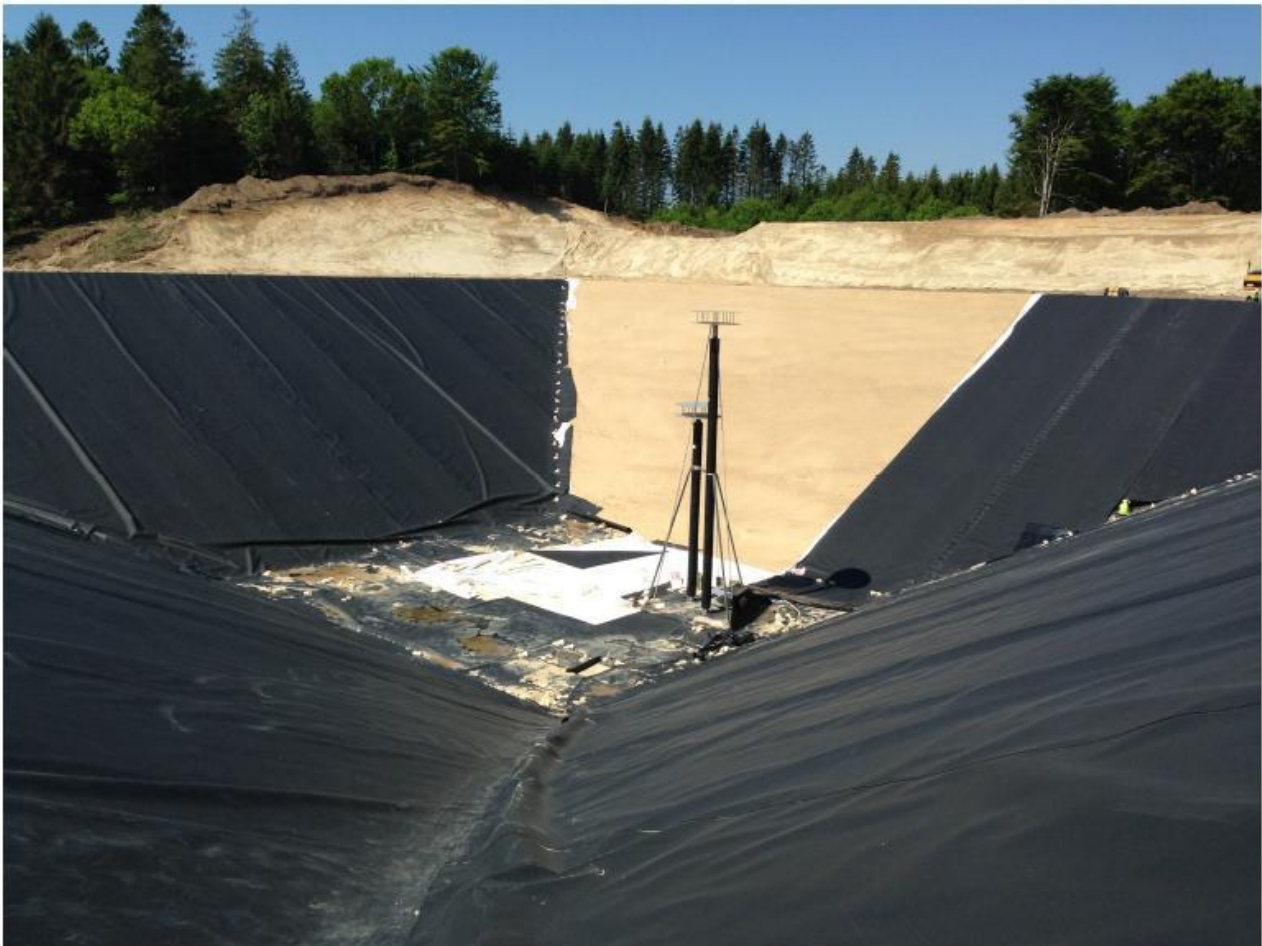

Figure 12. In-/outlet arrangement led through the bottom of the storage. Three pipes ending in a diffuser in the top, the bottom and the volume middle of the storage. Photo from the implementation of the SUNSTORE 3 storage in Dronninglund.

Task 45 Large Systems

Seasonal pit heat storages - Guidelines for materials & construction

IEA-SHC TECH SHEET 45.B.3.2, page 15 of 31



Figure 13. In-/outlet arrangement led through the side of the storage. Photo from the implementation of the SUNSTORE 4 storage in Marstal.

The in-/outlet arrangement can be made of stainless steel or mild steel with or without surface coating. Regardless of the steel type it is important to secure a water chemistry in the storage that will not cause corrosion of the steel parts. Corrosion can happen very fast because of the high temperature of the water. When using stainless steel the water chemistry is naturally not as critical as when using mild steel but in both cases a corrosion specialist should be consulted to secure a long lasting combination of materials and water chemistry.

Water quality

Water quality is important because of the steel parts in contact with the storage water. Not only the in-/outlet arrangement but also the piping, heat exchangers, pumps and eventual steel liner. During filling of the storage the water is softened by a water treatment system and eventually filtered by reverse osmosis. At the same time care should be taken to avoid particles of soil etc. to enter the storage during filling. If severe dirt has entered the storage during filling it can be necessary to clean the storage after the storage is

Task 45 Large Systems

Seasonal pit heat storages - Guidelines for materials & construction

IEA-SHC TECH SHEET 45.B.3.2, page 16 of 31

filled and finished with cover. It has been seen that severe contamination of soil particles in the storage can lead to bacterial corrosion of steel parts and clogging of heat exchangers.

After filling of the storage the water can be treated to avoid corrosion dependent of the steel quality used. Typically the pH-value is raised to a level around 9,8 to minimize corrosion of steel parts but it depends on the materials used. If aluminium parts are used a pH value of more than 8 will cause corrosion of the aluminium parts.

Location of storage and geotechnical conditions

Ground water conditions

Before establishing the storage some very important initial investigations have to be carried out. To avoid excessive heat loss from the storage it is important that the storage is not implemented in an area with floating ground water above the bottom level of the storage. If there is floating groundwater the storage has to be placed above the level of floating ground water. If the ground water is stationary or with negligible flow the storage can in principle be implemented but the ground water level has to be lowered during the implementation phase until the storage is filled with water.

Geotechnical investigations

To determine whether the soil can be used as bottom and sides for the liner and especially whether the excavated soil can be used as embankments around the storage it is necessary with geotechnical investigations. These investigations also help to define how steep it is possible to make the sides of the storage. A steeper storage is an advantage in relation to the size of the cover and thereby the implementation cost and the heat loss of the storage. Typically the sides of the storage can be made by an inclination of 1 on 2 (26.6° relative to horizontal). During implementation of the storage compression tests of the soil in the embankments should be carried out to ensure the stability of the embankments. The process of the geotechnical investigations are described in [6]

Task 45 Large Systems

Seasonal pit heat storages - Guidelines for materials & construction

IEA-SHC TECH SHEET 45.B.3.2, page 17 of 31

Calculation and optimization of pit heat storages

To be able to predict the behavior and performance of a pit heat storage in an energy system it is necessary to carry out calculations of the complete system. This can be done by making a mathematical model to simulate the system. The simulation can be done by different tools. The Danish energy systems with seasonal storages have been simulated in the software: TRNSYS.

Simulation tool (TRNSYS)

TRNSYS is a graphically based software for simulating the behavior of transient systems. It is primarily used for thermal and electrical energy systems. The modelling in TRNSYS is not straightforward and demands knowledge within TRNSYS simulation and the physics of energy systems.

When designing a pit heat storage it is necessary to know or simulate the system that it interacts in. This could typically be parameters as the heat consumption from a district heating system, the heat supply from different sources e.g. a solar plant, and meteorological data. The simulation is typically carried out in an hourly basis to simulate how it interacts and behave hour by hour throughout a year.

The pit heat storage can be modelled in TRNSYS with type 342 (Multiflow stratified thermal storage). This type models the storage geometrically as a cylinder. To get as close as possible to the reality the type is set up with the correct volume and the correct area of the top cover area. This means that the depth in the model is less than in reality, but this is of less importance. To set up the type it is also necessary to define parameters as conductivity, heat capacity and fluid density for the storage fluid and thickness and conductivity for the insulation. For the surrounding ground it is also necessary to define conductivity and heat capacity.

Figure 14 shows the user interface for a TRNSYS-model that is set up for a Danish CHP plant. The model was used to dimension and optimize the size of a solar plant, a pit heat storage, and an absorption heat pump. From the results it was possible to calculate the profitability of the investment.

Task 45 Large Systems

Seasonal pit heat storages - Guidelines for materials & construction

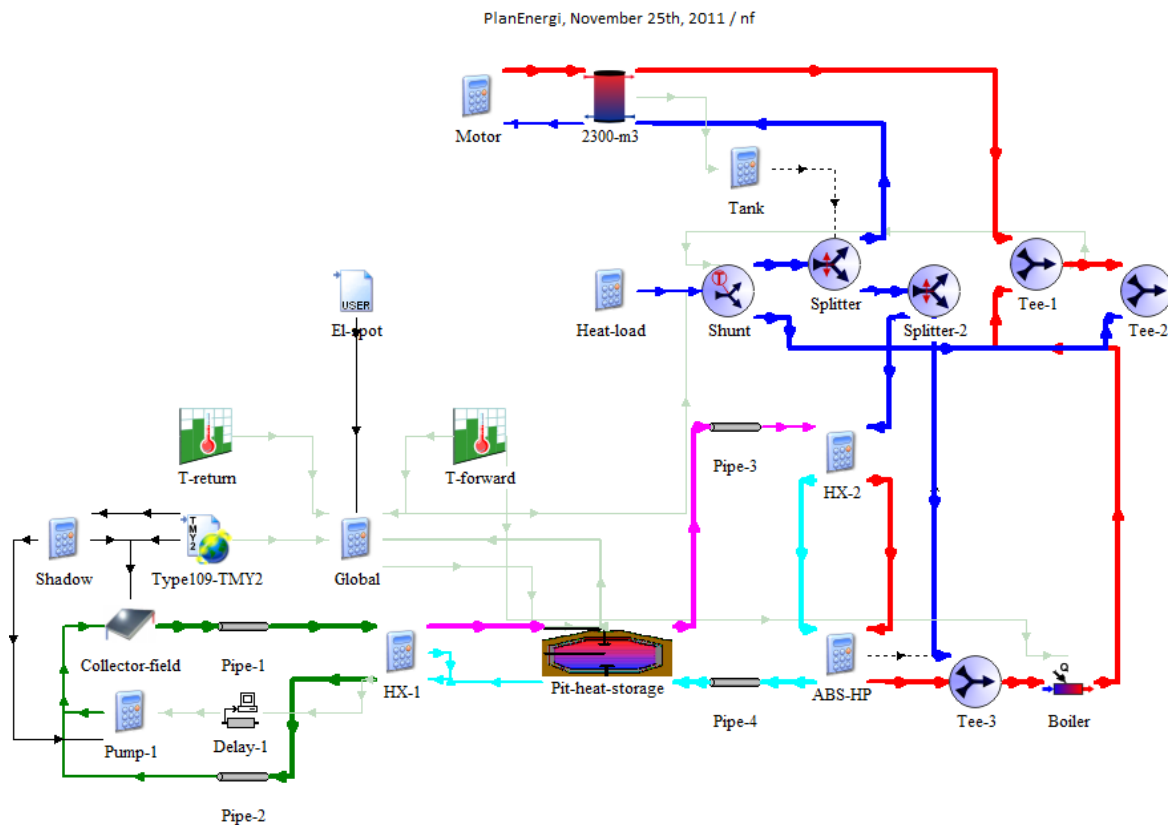

Figure 14. Example of the graphical user interface for a TRNSYS-model of a pit heat storage connected to a district heating CHP plant, a solar collector field, and an absorption heat pump. The model corresponds to the principal diagram of the system shown in figure 15. The model was used to simulate and optimize a system for Gram district heating company.

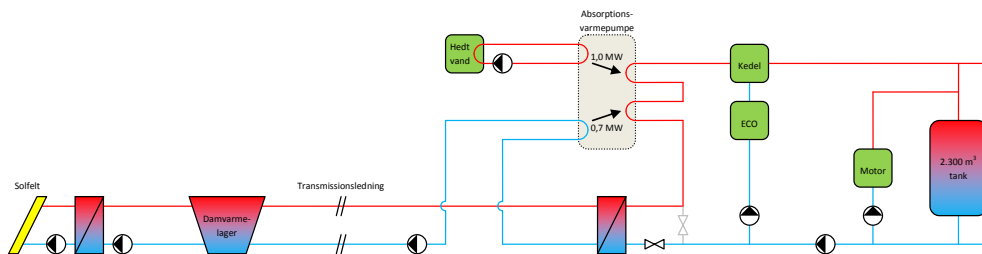

Figure 15. Principal diagram made for Gram District heating company by PlanEnergi. The system consists of a solar plant, a pit heat storage and an absorption heat pump connected to a CHP plant.

Optimization of storage size and shape

For pit heat storages integrated in an overall system it is important to find the correct dimensions of the individual parts of the system. This can be done by optimization and can make the difference between a

Task 45 Large Systems

Seasonal pit heat storages - Guidelines for materials & construction

IEA-SHC TECH SHEET 45.B.3.2, page 19 of 31

profitable and a non-profitable investment. By use of a generic optimization program like genOpt the TRNSYS model can be run automatically several times at varied parameters to minimize a specific target. By including an economical model in the TRNSYS model it is possible to minimize the total cost including the financial cost of the investment. As an example the system shown in figure 15 was optimized by varying the size of the solar plant, the size of the pit heat storage and the size of the heat pump. From the initial qualified guess to the optimal dimensioned system there was a difference of 33% in the total savings of the yearly heat price. The numbers of the initial guess and the optimized numbers can be seen in table 1 and table 2. It can be seen that a pit heat storage of 52 000 m³ was seen as a suitable size but the optimal size was 104 000 m³. In the same manner optimization can be used to determine the optimal thickness of insulation of the cover of a pit heat storage or other parameters that influence the cost and performance of the system.

		0. Reference	1. SUNSTORE 4	2. SUNSTORE 4
Solar fraction	-	14.4%	43.8%	55.7%
Solar collector area	m ²	10,073	32,000	40,000
Pit heat storage volume	m ³	0	52,000	104,000
Biomass boiler + abs. HP	-	0%	100%	234%
Investment				
Solar collectors	DKK		32,900,000	44,900,000
Pit heat storage	DKK		10,900,000	17,800,000
Biomass boiler + abs. HP	DKK		7,000,000	13,700,000
Changes in CHP plant	DKK		2,500,000	2,500,000
Purchase of land	DKK		3,000,000	3,000,000
Solar station	DKK		3,000,000	3,000,000
Extra equipment in tank	DKK		200,000	200,000
Electric boiler	DKK		5,000,000	5,000,000
Technical assistance	DKK		3,500,000	3,500,000
Total	DKK		68,000,000	93,600,000

Table 1. Need for investments in two SUNSTORE plants calculated by PlanEnergi for Gram district heating company. 0. is the reference situation (existing plant), 1. is the initial guess of the size of the different parts of the plant, 2. is the optimized plant. 1 DKK = 7.46 €.

Task 45 Large Systems

Seasonal pit heat storages - Guidelines for materials & construction

Base case		0. Reference	1. SUNSTORE 4	2. SUNSTORE 4
Investment	DKK	0	68 000 000	93 600 000
Operation costs*	DKK/year	10 644 000	4 649 000	2 114 000
Increased heat efficiency	DKK/year	0	-300 000	-300 000
Electric boiler	DKK/year	0	-700 000	-700 000
Operation costs in total	DKK/year	10 644 000	3 649 000	1 114 000
Operation savings	DKK/year	0	6 995 000	9 530 000
Simple payback time	years	-	9.7	9.8
Capital costs**	DKK/year	0	4 760 000	6 552 000
Savings	DKK/year	0	2 235 000	2 978 000

*) Calculated using a simulation tool called energyPRO.
 **) Calculated as 7%/year of the investments corresponding to a 20 year annuity loan with an interest of 3%/year.

Table 2. Economy from the company's point of view for: 1. a SUNSTORE plant dimensioned from an initial guess, 2. the SUNSTORE plant dimensioned from an optimization. 1 DKK = 7.46 €.

Costs of pit heat storages

Based on the experiences from the implemented storages in Marstal and Dronninglund and price information for excavation, materials and implementation the price curve in figure 16 is made. The economy of scale is clear. Going from 75 000 m³ to 200 000 m³ the expected specific costs are reduced by more than 20% (from 36 to 28 €/m³).

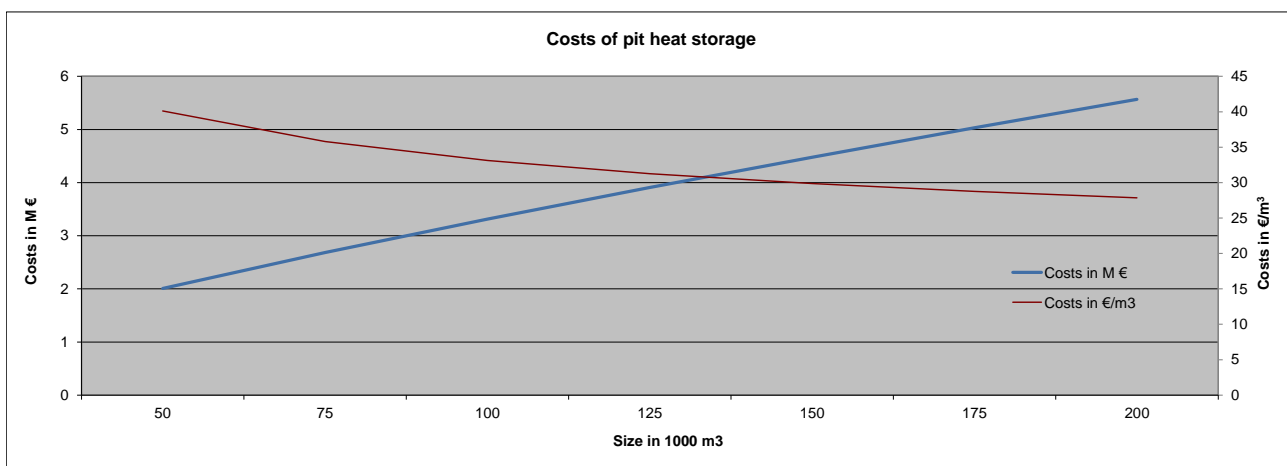

Figure 16. Estimation of the costs for a pit heat storage as a function of the size of the storage.

Task 45 Large Systems

Seasonal pit heat storages - Guidelines for materials & construction

IEA-SHC TECH SHEET 45.B.3.2, page 21 of 31

Examples of pit heat storages

In the following four examples of pit heat storages implemented in Denmark are described.

Ottrupgård

- Constructed: 1993-95
- Size: 1,500 m³
- Price: 0.225 mio. €, equivalent to 150 €/ m³ or 5.17 €/ kWh
- Temperature range: 35-60 ° C
- Capacity: 43.5 MWh
- Load and discharge power: 390 kW (corresponding to the solar panels max. Power)
- Estimated loss through lid: 24 MWh / year
- Estimated loss through side: 59 MWh / year
- Estimated loss through bottom: 2 MWh / year

The heating storage in Ottrupgård is mentioned in [7], [8] and [9]. The measured loss is according to [9] 70 MWh/year. The storage was built with clay seal, inspired by the technique used in landfills.

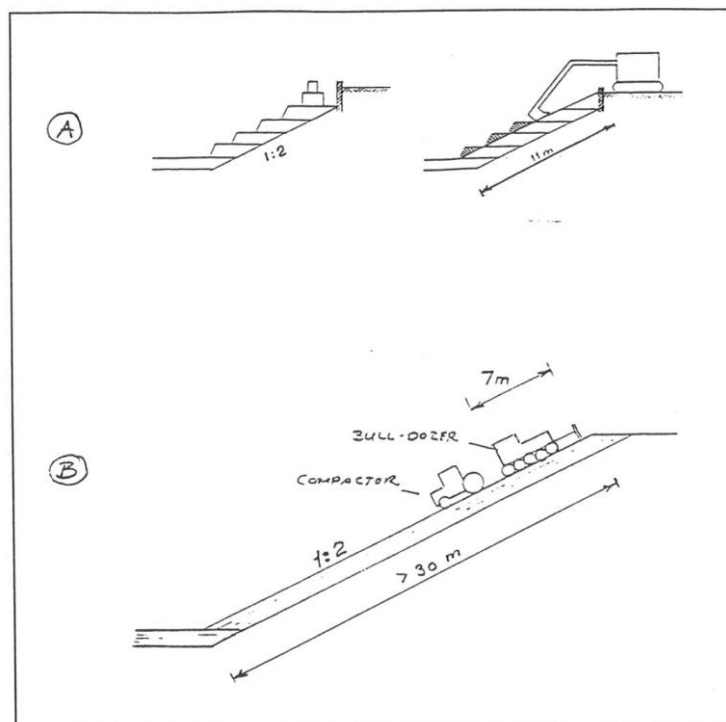

Figure 17 The laying of clay membrane [7].

Task 45 Large Systems

Seasonal pit heat storages - Guidelines for materials & construction

IEA-SHC TECH SHEET 45.B.3.2, page 22 of 31

Before the storage was built, experiments were performed at the then Geotechnical Institute (now GEO). The experiments showed that the glacial till at a humidity of 14% could be used, but would not be seal proof. Therefore an EPDM-liner was deliberately put on the back-side. The lid was done with prefabricated cold storage elements with tongue and groove. The elements were joined with silicone, and joints sealed with sealing tape.

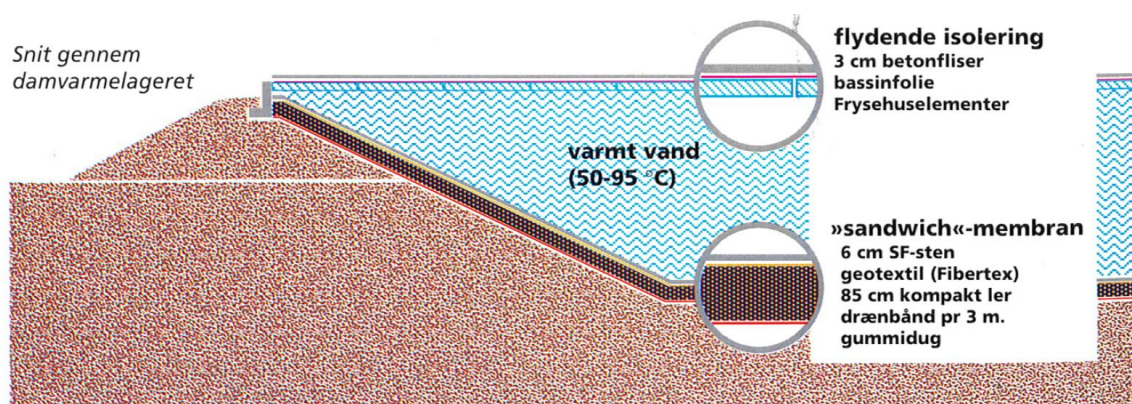

Figure 18 Cross section through the pit heat storage, Ottrupgård (brochure).

Experience during the establishment of the storage was that the clay sealing was both expensive and cumbersome. It rained most of September 1993, resulting in that the clay humidity was too high (20 %). The work with the clay sealing was therefore first conducted in June 1994. Also, the assembly of the lid proved to be both expensive and cumbersome when the seal work had to be carried out under the cover with the lid resting on an iron construction.



Figure 19 Sealing of joints on the water side [7].

Task 45 Large Systems

Seasonal pit heat storages - Guidelines for materials & construction

IEA-SHC **TECH SHEET** 45.B.3.2, page 23 of 31

The storage is still in operation in connection to 560 m² solar thermal, and it will probably last even a few years. The storage is designed and constructed such that it is intentionally leaking so that water constantly seeps through the clay sealing and will therefore not crack. The water loss has been much larger than expected, and the storage was therefore emptied after some years of operation, where a bentonite seal was applied to the clay seal in order to add further seal. This reduced water loss from 6 m³ / day to 1.6 m³ / day. However the water loss is since raised to just above 3 m³ / day.

Task 45 Large Systems

Seasonal pit heat storages - Guidelines for materials & construction

IEA-SHC TECH SHEET 45.B.3.2, page 24 of 31

Marstal, SUNSTORE 2

- Built: 2003
- Size: 10,000 m³
- Price: 0.670 mio. €, equivalent to 67 € / m³ or 1.05 € / kWh
- Temperature range: 35-90 ° C
- Capacity: 638 MWh
- Load and discharge power: 6,510 kW (corresponding to the associated solar installations max. Power).
- Losses: 402 MWh / year (calculated)

Marstal District Heating received in 2001 the grant from the Danish Energy Agency and the EU's 5th framework programme to expand solar collector area of 9,000 m² to 18,300 m². The solar thermal would then cover about solar 30 % of the annual heat demand. The need for storage of solar heat is at the same time increased, and for that purpose there was included a pit heat storage in the project of 10,000 m³. The pit heat storage was a further development of the heat storage in Ottrupgård on two essential points.

The clay sealing with EPDM liner on the back side was replaced by a liner made of polyethylene (PE), which could be welded. Before that, three liners were tested at the Danish Technological Institute (a PP liner and two PE liners). The PE-liners showed the longest durability. [2].

The assembly of the lid were changed so that the lid was fixed (in Ottrupgård the lid moves up and down with the water surface), and was constructed on the site. Calculations showed that steam would penetrate the cover bottom liners made of HDPE and condense in the insulation of mineral wool. Therefore, a vapor barrier of 3 layer PE combined with 2 layers of aluminum was admitted.

The structural changes should ensure a price reduction while the durability of the storage was expected to be more than 20 years. The goal was to test a storage construction, which for stores above 50,000 m³ could be established for less than 35 € / m³. Figure 2.2.6 shows a cross-section of the store.

Task 45 Large Systems

Seasonal pit heat storages - Guidelines for materials & construction

IEA-SHC TECH SHEET 45.B.3.2, page 25 of 31

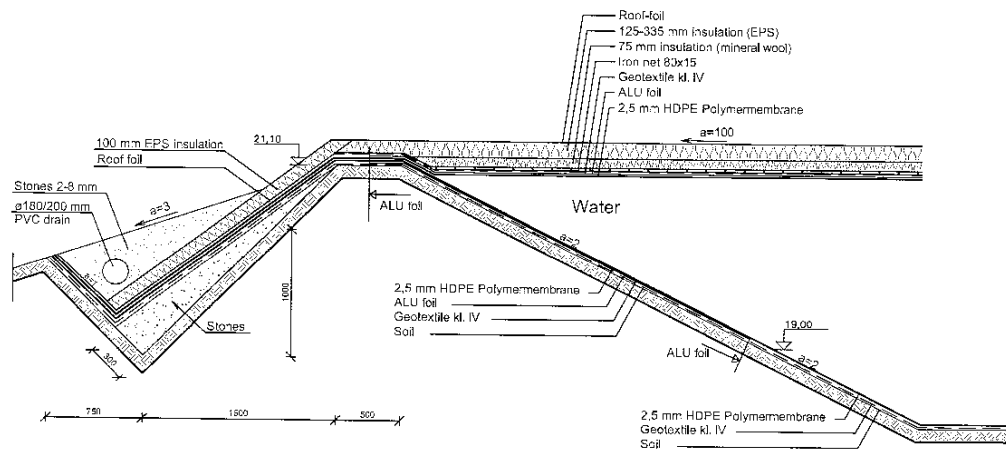

Figure 20 Cross section of the pit heat storage constructed in Marstal in the SUNSTORE 2 project [10].

The storage was established during the summer of 2003. During the establishment of the storage some problems with the handling of HDPE liner occurred. The liner is black and was expanding rapidly in the sun, creating big folds that had to be straightened simultaneously with the filling of water.

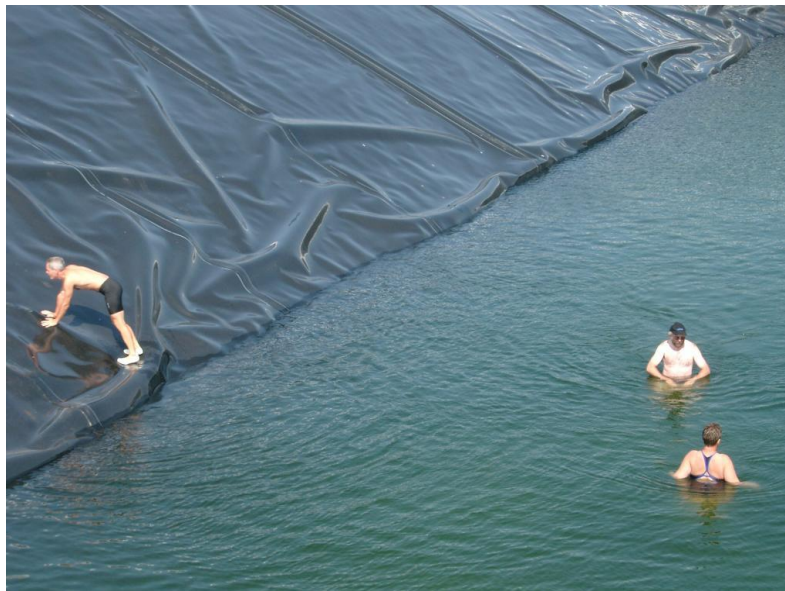

Figure 21 The folds are inspected under the water filling [10].

At the time, the storage was completely filled with water a leak was found at the inlet- and pumping pipes. The leakage was found at a location where there is no channel to be welded (and pressure tested), and was caulked by a diver by means of a HDPE jacket which was filled with silicone.

Task 45 Large Systems

Seasonal pit heat storages - Guidelines for materials & construction

IEA-SHC TECH SHEET 45.B.3.2, page 26 of 31



Figure 22 Inlet and outlet pipes. The leak was in the liner weld during one of the pipes [10].

During operation of the storage the following problems were found:

- There was air (freed from the water by heating) that formed air pockets under the lid. When the lid is not rigid, the pockets grew bigger and bigger.
- There were formed water ponds at the lid terminals. The lid is held down by the valves, which form the vacuum when there is wind, but at the same time are pressing down a little in the lid to form a hollow which can be filled by rain water. When the water does not evaporate before the next rains, this fills additional water in, and the lid is sinking further.
- After 2 years of operation a leak was found in the lid. The leak occurred at the manhole where there was used a corrugated tube of the wrong HDPE material. By this the insulation was filled with water, and both mineral wool and EPS took so much water that the insulating capacity virtually disappeared.
- For subsequent cutting of the lid, it was found that the PE / aluminum vapor barrier was not intact, and the solution will therefore not be implemented in the future.

The 10,000 m³ storage in Marstal is still in use and allocated EUDP means to test a new lid design. At the moment the work consists of developing a solution with PUR foam elements but without the cost and construction compliance drawbacks from the Ottruppård solution.

Task 45 Large Systems

Seasonal pit heat storages - Guidelines for materials & construction

IEA-SHC TECH SHEET 45.B.3.2, page 27 of 31

Marstal, SUNSTORE 4

- Constructed: 2011-12
- Size: 75,000 m³
- Price: 2.67 mio. € excl. transmission line, corresponding to 35.7 € / m³ or 0.375 € / kWh
- Temperature range: 10 - 90 ° C
- Capacity: 6,960 MWh
- Load and discharge power; 10.5 MW (equivalent to the coupled collectors)
- Loss (calculated): 2,475 MWh / year

Marstal District Heating received in 2010 grants from the EU's 7th framework programme for the expansion of energy production plant, for the solar thermal to cover up to half of the heat demand, and the rest of the heating requirement to be covered by wood chips from a wood-fired cogeneration plant. The solar heating system was increased by 15,000 m² to 33,300 m² and there was added 75,000 m³ pit heat storage, a heat pump of 1.5 MW_{heat}, a wood chip boiler of 4 MW and an Organic Rankine Cycle of 750 kW.

A principal diagram is shown in figure 23.

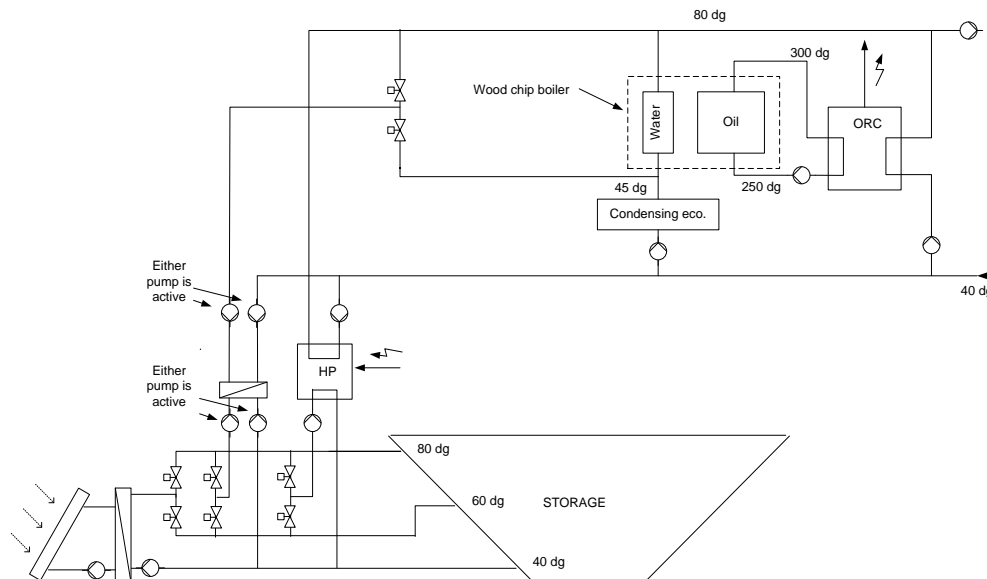

Figure 23 Principal diagram of the SUNSTORE 4 project [11].

The pit heat storage was a development of the 10,000 m³ storage, established under the SUNSTORE 2 project. The below points should be amended:

- Formation of air pockets under the lid was to be prevented.
- Formation of water ponds on top of the lid should be prevented.
- The insulation should be water-resistant.
- The vapor barrier should be changed.

Task 45 Large Systems

Seasonal pit heat storages - Guidelines for materials & construction

IEA-SHC TECH SHEET 45.B.3.2, page 28 of 31

The principle of the assembly of the lid is to use drill collars to get the lid to fall toward the center so that rain water is collected and pumped away from a pump sump. The lid is moving with the water surface. The inventory design was like in the SUNSTORE 2 project (truncated cone sealed with plastic liner and inclination 1: 2). The lid solution is shown in figure 24.

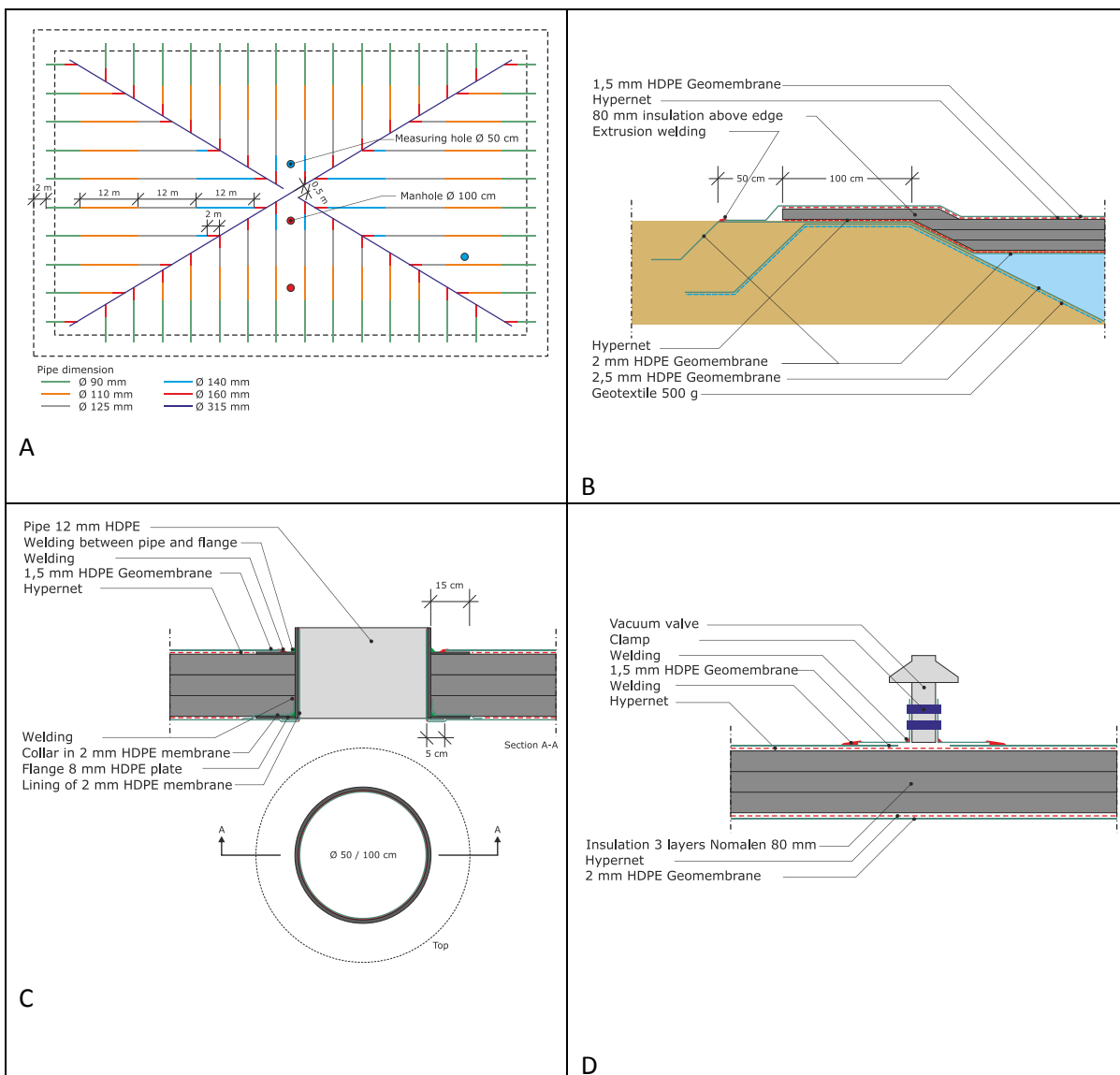

Figure 24 Drawings of the lid solution in the SUNSTORE 4 project [12]. A: top view of the lid with the drill collar shown. B: edge solution. C: manhole. D: cuts with vacuum valve.

The storage should have been established during the summer and autumn of 2011, but a cloudburst in mid-August slowed the work so much that the side and bottom liners had to be established in November. The

Task 45 Large Systems

Seasonal pit heat storages - Guidelines for materials & construction

IEA-SHC TECH SHEET 45.B.3.2, page 29 of 31

water filling took place in December 2011 and January and February 2012. The work with the lid construction took place from April 2012 and the storage was heated from July 2012.

Especially excavation to the storage caused major problems due to a rainy summer. Fitting the side and bottom liner went smoothly because of the very lucky weather in November. Fitting the lid was difficult because there could not get any water into the lid.



Figure 25 Figure 2.2.11: Construction of the storage in Marstal [13]. a: inlet and outlet pipes are hoisted into place. b: the storage after the cloudburst. c: The liner work. d: the lid is built.

Task 45 Large Systems

Seasonal pit heat storages - Guidelines for materials & construction

IEA-SHC TECH SHEET 45.B.3.2, page 30 of 31

Dronninglund, SUNSTORE 3

- Constructed: 2013
- Size: 60,000 m³
- Price: approx 2.28 mio. € excl. transmission lines corresponding to 37.9 € / m³ or 0.416 € / kWh
- Temperature range: 10 - 90 ° C
- Capacity: 5,570 MWh
- Input and pumping capacity: 26.1 MW (equivalent to solar panels max. Output power)
- Loss (calculated): 2,260 MWh / year

Dronninglund District Heating was in 2009 granted EUDP support for an energy production system consisting of 35,000 m² of solar panels, 60,000 m³ pit heat storage and a 3 MW heat pump. The construction phase is first initiated in the spring of 2013, partly due to that the storage had to be moved, partly because of neighbor objections to the plan authorization. The excavation into the heat storage is made from mid-March to mid-May 2013 and the liner work was completed in mid-June, where after the water filling began. The construction is as in Marstal, but the following precautions are taken to prevent corrosion:

- The water is cleaned from limestone and salts (osmosis)
- pH is kept at 9.8
- Water quality is monitored regularly during and after filling
- The storage is cleaned from dirt before the water filling
- A diver cleans from dirt when the lid closes the storage
- Filters are placed before heat exchangers, to prevent clogging

Inlet and outlet arrangement is made of stainless steel.

Figure 12 (p 14) shows a picture of the storage under construction.

Seasonal pit heat storages - Guidelines for materials & construction

IEA-SHC TECH SHEET 45.B.3.2, page 31 of 31

References

- [1] Ochs F., Heidemann W. and Muller-Steinhagen H. (2008) Seasonal Thermal Energy Storage: A Challenging Application For Geosynthetics. *EuroGeo4 4th. European Geosynthetics Conference*, 7-10 September, Edinburgh, Scotland, Paper no. 105.
- [2] Pedersen S. Teknologisk Institut, Nielsen U. Plastconsult, Fastlæggelse af levetider for plastlinere til sæsonvarmelagre, Energistyrelsens Udviklingsprogram for vedvarende energi, j.nr. 551181/97-0075, 2000
- Pedersen S. Teknologisk Institut, Fastlæggelse af levetider for 2 HDPE plastlinere til sæsonvarmelagre, UVE-projekt, ENS. J. nr. 51181/01-0065, 2004
- Paranowska I. Teknologisk Institut, Ældningstest på 2,5 mm HD-PE Junifol fra JUTA til varmelager, afslutning, 2011
- Pedersen S. Teknologisk Institut, Ældningstest på 2,5 mm HD-PE liner fra AGRU til varmelager – afsluttende rapport, 2013
- [3] Scheirs J., A Guide to Polymeric Geomembranes, 2009
- [4] Massey L. K., Permeability Properties of Plastics and Elastomers, 2nd. ed., 2003
- [5] Heller A., Wesenberg C. and Hansen A., Udvikling af flydende lågkonstruktioner til damvarmelagre – Løsning i tyndpladestål, Rapport BYG DTU R-033, 2002
- [6] Andersen J. D., Bødker L. and Jensen M. V. (2013) Large Thermal Energy Storage at Marstal District Heating. *Proceedings of the 18th International Conference on Soil Mechanics and Geotechnical Engineering*, 2-6 September, Paris, France, pp 3351-3355
- [7] Ottrupgård, 1.500 m³ damvarmelager. Slutrapport. PlanEnergi, september 1995.
- [8] Ottrupgård, 1.500 m³ damvarmelager. Målerapport. PlanEnergi, 1996, 1997 og 1998.
- [9] Ottrupgård, 1.500 m³ damvarmelager. Målerapport, 1998 til 2001. PlanEnergi, juli 2002.
- [10] Final Technical Report, SUNSTORE 2. Marstal Fjernvarme, 2005.
- [11] SUNSTORE 4. Deliverable 2.1. Design of the overall energy system. PlanEnergi, 2013
- [12] SUNSTORE 4. Deliverable 2.2. Design of the pit heat storage. PlanEnergi, 2013
- [13] Two approaches of seasonal heat storing. Pit heat storage and borehole thermal energy storage. Morten V. Jensen og Niels From, PlanEnergi. Conferencepaper til 1st SDH conference, Malmø 2013.